

DFM 47GR0521-ML Technical Reference Manual



1. Quick Facts	5
2. Dimensional Diagrams	7
2.1 DFM 47GR0521-ML Board Camera	7
3. I/O Connector	8
3.1 6-Pin I/O Connector	8
3.2 Power Connector	9
4. Spectral Characteristics	10
4.1 Spectral Sensitivity - AR0521	10
5. Camera Controls	11
5.1 Sensor Readout Control	11
5.1.1 Pixel Format	11
5.1.1.1 8-Bit Bayer Raw	12
5.1.1.2 12-Bit Packed Bayer Raw	12
5.1.1.3 16-Bit Bayer Raw	12
5.1.1.4 YUV 4:2:2	12
5.1.1.5 YUV 4:1:1	13
5.1.1.6 RGB24	13
5.1.1.7 8-Bit Monochrome	13
5.1.2 Resolution	13
5.1.3 Readout Modes	14
5.1.4 Frame Rate	15
5.1.5 Partial Scan Offset	17
5.1.6 Image Flipping	18
5.2 Image Sensor Control	18
5.2.1 Exposure Time	18
5.2.2 Gain	18
5.2.3 Black Level	19
5.3 Automatic Exposure and Gain Control	19
5.3.1 Auto Exposure	20
5.3.2 Auto Gain	20
5.3.3 Auto Reference Value	20
5.3.4 Highlight Reduction	20
5.3.5 Auto Exposure Limits	21
5.3.6 Auto Gain Limits	22
5.4 Trigger	22
5.4.1 Trigger Mode	22
5.4.2 Trigger Polarity	22
5.4.3 Software Trigger	23
5.4.4 Trigger Burst Count	23
5.4.5 Trigger Source	23



5.4.6	Trigger Overlap	24
5.5	Trigger Timing Parameters	24
5.5.1	Trigger Delay	24
5.5.2	Trigger Debounce Time	25
5.5.3	Trigger Mask Time	25
5.5.4	Trigger Noise Suppression Time	25
5.6	Digital I/O	26
5.6.1	Line Selector	26
5.6.2	Line Name	26
5.6.3	Line Mode	27
5.6.4	Line Inverter	27
5.6.5	Line Status	27
5.6.6	Line Status Invalidate	27
5.6.7	Line Source	28
5.6.8	Line Format	28
5.6.9	User Output Selector	28
5.6.10	User Output Value	29
5.7	Strobe	29
5.7.1	Strobe Enable	29
5.7.2	Strobe Polarity	29
5.7.3	Strobe Operation	30
5.8	White Balance	30
5.8.1	Auto White Balance	30
5.8.2	White Balance Mode	30
5.8.3	Manual White Balance	31
5.9	Image Processing	33
5.9.1	Gamma	33
5.9.2	Lookup Table	33
5.10	Color Processing	35
5.10.1	Hue	35
5.10.2	Saturation	35
5.10.3	Color Correction Matrix	35
5.11	Region of Interest for Auto Functions	38
5.11.1	Auto Functions ROI Enable	38
5.11.2	Auto Functions ROI Preset	38
5.11.3	Auto Functions ROI Custom Rectangle	39
5.12	User Sets	39
5.12.1	User Set Selector	40
5.12.2	Load User Set	40
5.12.3	Save User Set	40
5.12.4	Default User Set	40
5.13	Precision Time Protocol	41
5.13.1	PTP Enable	41



5.13.2	PTP Status	41
5.14	Action Scheduler	42
5.14.1	Action Selector	42
5.14.2	Action Scheduler Time	42
5.14.3	Action Scheduler Interval	42
5.14.4	Action Scheduler Commit	43
5.14.5	Action Scheduler Cancel	43
5.15	Events	43
5.15.1	Event Selector	43
5.15.2	Event Notification	44
5.15.3	Event Frame Trigger Missed	44
5.15.4	Event Line1 Falling Edge	44
5.15.5	Event Line1 Rising Edge	45
5.15.6	Event Test	45
5.16	Bandwidth Control	46
5.16.1	Device Link Throughput Limit Mode	46
5.16.2	Device Link Throughput Limit	46
6.	Temperature Measurement Point	48
7.	Revision History	49



1 Quick Facts

General	
Vision Standard	GigE Vision
Dynamic Range	12 bit
Resolution	2592x1944
Frame Rate at Full Resolution	22
Pixel Formats	8-Bit Bayer (GR) 12-Bit Bayer Packed (GR) 16-Bit Bayer (GR) YUV 4:2:2 YUV 4:1:1 YUV 4:1:1 RGB24 8-Bit Monochrome

Optical Interface	
IR-Cut filter	No
Sensor Type	OnSemi AR0521
Shutter Type	Rolling
Sensor Format	1/2.5 inch
Pixel Size	2.2 μm
Lens Mount	M12

Electrical Interface	
Interface	GigE
Supply Voltage	4.75 VDC to 25 VDC
Current Consumption	approx 150 mA @ 12 VDC

Mechanical Data	
Dimensions	H: 36 mm, W: 38 mm, L: 17 mm
Mass	12 g



Adjustments	
Shutter	100 μ s to 30 s
Gain	0 dB to 11,81 dB

Environmental Conditions	
Board Temperature (operating) *	0 °C to 70 °C
Temperature (storage)	-20 °C to 80 °C
Humidity (operating)	20 % to 80 % (non-condensing)
Humidity (storage)	20 % to 95 % (non-condensing)

*) See section [Temperature Measurement Point](#) for details.



2 Dimensional Diagrams

2.1 DFM 47GR0521-ML Board Camera

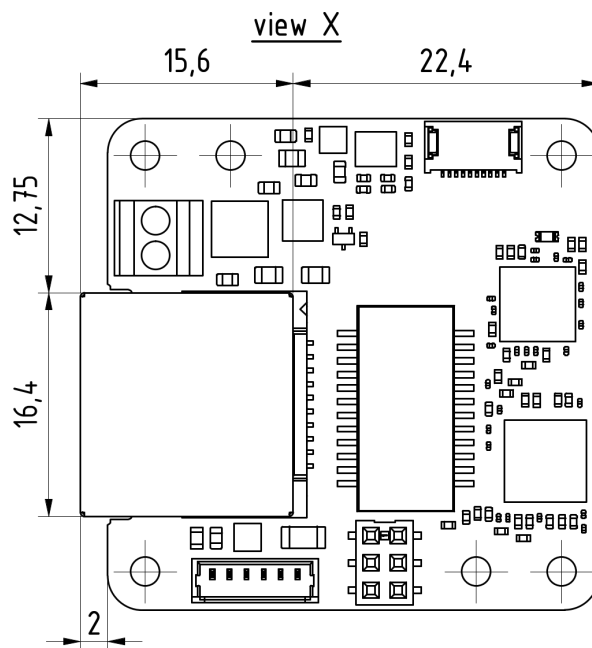
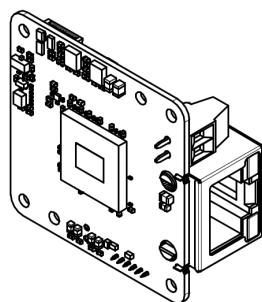
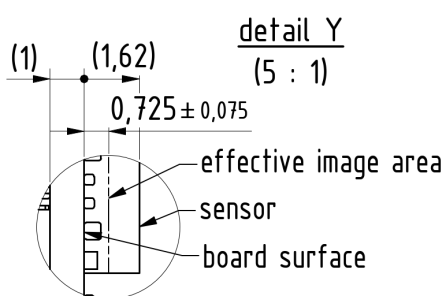
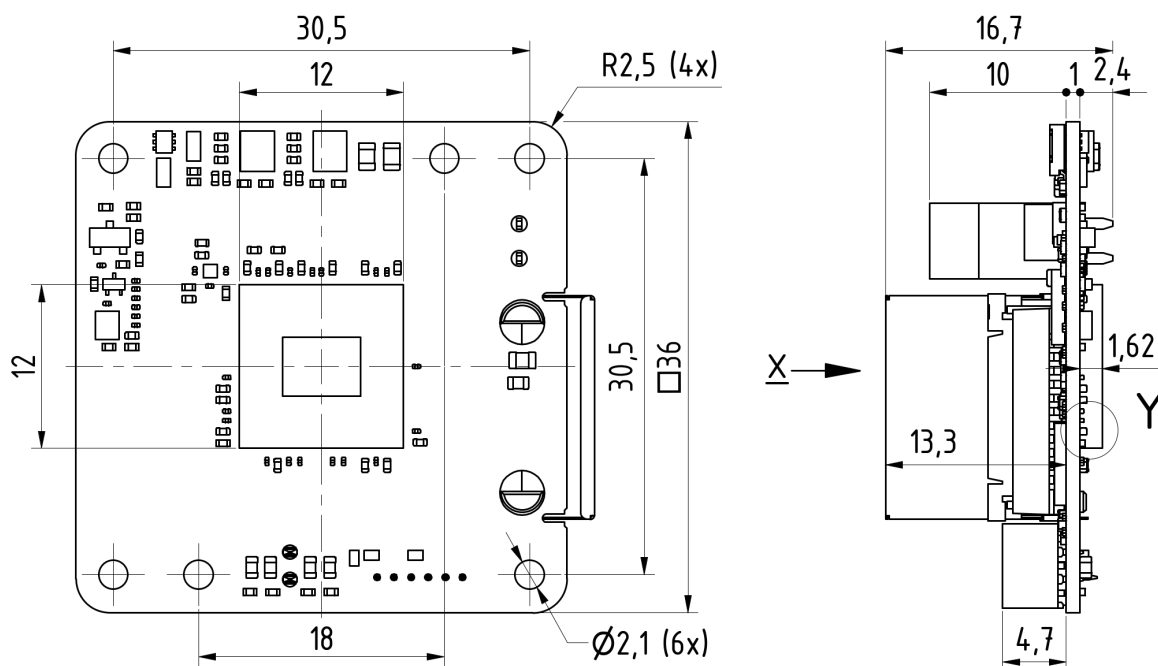

Dimensions: mm
Tolerances: DIN ISO 2768-f
306-23-00-00

3 I/O Connector

3.1 6-Pin I/O Connector

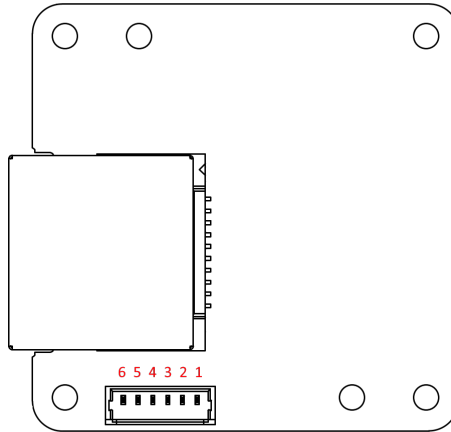

Rear view of camera

Pin	Signal	Type ¹	Remarks	Min	Max	LineSelector ²
1	TRIGGER_IN	I	min 0.15mA @ 3.0V	3.0 V	25 V	Line1
2	GPOUT1	O	Open Drain, max 0.5A		25 V	Line0
3	GPOUT2	O	Open Drain, max 0.5A		25 V	Line2
4	GND	G				-
5	GND	G				-
6	VIN	P		4.75 V	25 V	-

¹ P: Power, G: Ground, O: Output, I: Input

² Set [Line Selector](#) to configure or query this pin.

The part number of this PicoBlade connector is Molex-53047-0610. To create an I/O cable, a PicoBlade connector (Molex-51021-0600) or a PicoBlade cable assembly (e.g. Molex-15134-0600) is required.



3.2 Power Connector

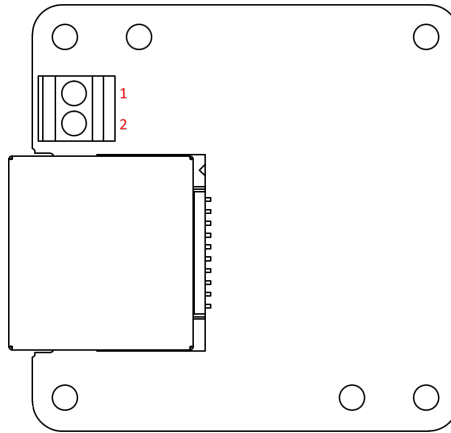

Rear view of camera

Pin	Signal	Type ¹	Min	Max
1	VIN	P	4.75 V	25 V
2	GND	G		

¹ P: Power, G: Ground



4 Spectral Characteristics

4.1 Spectral Sensitivity - AR0521

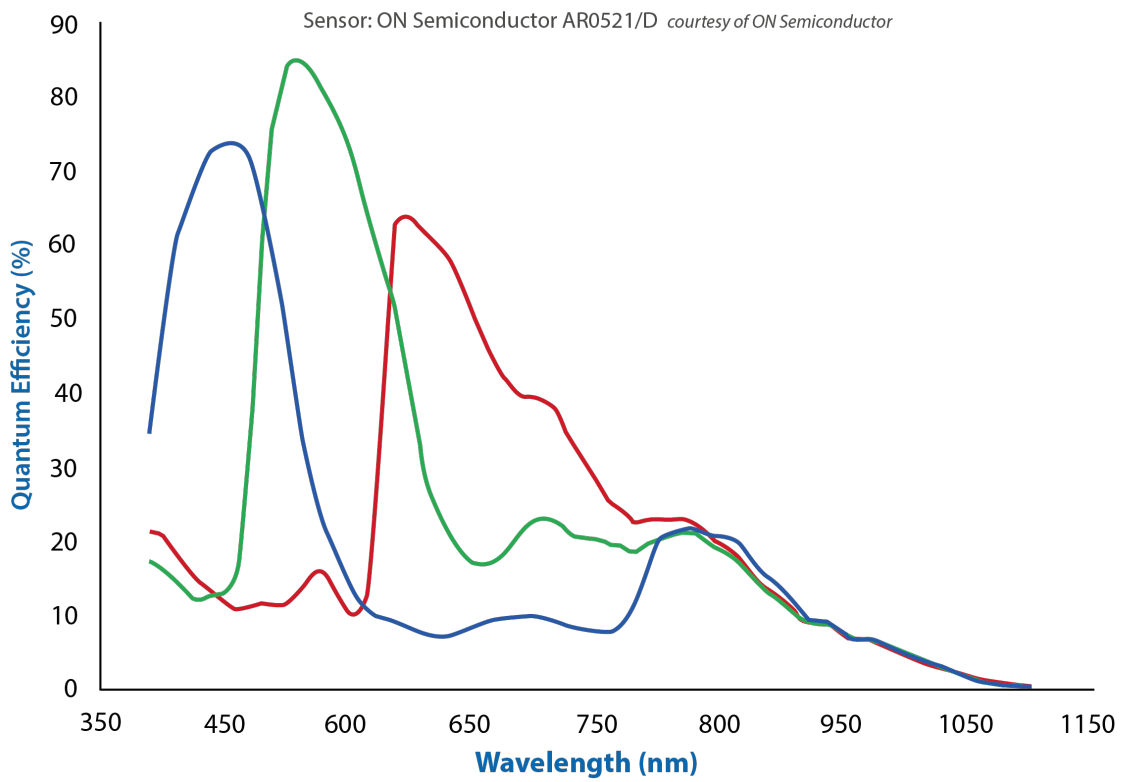



5 Camera Controls

This section describes the parameters available for the DFM 47GR0521-ML camera.

The actual name of the parameter depends on the driver technology used to access the camera. Parameter names are listed for the most common ways to access the cameras:

- *GigE Vision (IC Imaging Control 4, or via 3rd party driver)*
- *IC Imaging Control 3.x (on Windows, via Device Driver for The Imaging Source GigE Cameras)*

5.1 Sensor Readout Control

5.1.1 Pixel Format

The pixel format defines the data type of the pixels transmitted to the computer. The bits per pixel needed for a particular pixel format influence the required bandwidth.

The driver technology used to access the camera significantly impacts the way the pixel format is controlled:

- When using *IC Imaging Control 4* or *GigE Vision*, the pixel format is controlled through the `PixelFormat GenICam` feature.
- When using *IC Imaging Control 3.x*, the pixel format is part of the video format - a parameter which combines pixel format, resolution and readout mode. For more information, refer to the *IC Imaging Control 3.x* documentation sections on `VideoFormat` and `VideoFormatDesc`.

The DFM 47GR0521-ML color camera supports multiple pixel formats with variable bits-per-pixel settings. The names of the pixel formats and the way to select them depends on the driver used to control the camera. The following table contains a short overview of all possible formats followed by a more detailed description.

Pixel Format	Bits Per Pixel	GigE Vision	TIS GigE Driver
8-Bit Bayer (GR)	8	BayerGR8	RGB32, Y800
12-Bit Packed Bayer (GR)	12	BayerGR12p	RGB64, Y16
16-Bit Bayer (GR)	16	BayerGR16	RGB64, Y16
YUV 4:2:2	16	YUV422_8	YUY2
YUV 4:1:1 (a)	12	YCbCr411_8	
YUV 4:1:1 (b)	12	YCbCr411_8_CbYYCrYY	Y411
RGB24	24	BGR8	RGB24
8-Bit Monochrome	8	Mono8	



5.1.1.1 8-Bit Bayer Raw

This format transmits data using one byte for each pixel.

GigEVision drivers see this pixel format as one of the 8-bit bayer raw formats (`BayerGR8`, `BayerRG8`, `BayerGB8`, `BayerBG8`).

The *Device Driver for The Imaging Source GigE Cameras* simplifies this variety of possible pixel formats and offers two video formats instead: `RGB32` and `Y800`. The `RGB32` format results from the driver's automatic debayering of the raw image data, while the `Y800` format contains the raw data which is reinterpreted as monochrome.

5.1.1.2 12-Bit Packed Bayer Raw

This format transmits data using 3 bytes for each pair of 2 consecutive pixels.

GigEVision drivers see this pixel format as one of the 12-bit packed bayer raw formats (`BayerGR12Packed`, `BayerRG12Packed`, `BayerGB12Packed`, `BayerBG12Packed`).

The *Device Driver for The Imaging Source GigE Cameras* simplifies this variety of possible pixel formats and offers two video formats instead: `RGB64` and `Y16`. The `RGB64` format results from the driver's automatic debayering of the raw image data, while the `Y16` format contains the raw data which is reinterpreted as monochrome. Since the DFM 47GR0521-ML camera offers both 12-bit packed and 16-bit bayer raw pixel formats, the driver uses the 12-bit packed format when the `RGB64` or `Y16` video format is selected.

5.1.1.3 16-Bit Bayer Raw

This format transmits data using 2 bytes for each pixel.

The sensor of the DFM 47GR0521-ML camera is not able to provide 16-bit data output. The pixel data is transmitted in the most significant bits. This allows application programs to ignore the sensor-specific data type and to treat the data as if the sensor outputs 16 bits.

GigEVision drivers see this pixel format as one of the 16-bit packed bayer raw formats (`BayerGR16`, `BayerRG16`, `BayerGB16`, `BayerBG16`).

The *Device Driver for The Imaging Source GigE Cameras* simplifies this variety of possible pixel formats and offers two video formats instead: `RGB64` and `Y16`. The `RGB64` format results from the driver's automatic debayering the raw image data, while the `Y16` format contains the raw data which is reinterpreted as monochrome.

5.1.1.4 YUV 4:2:2

This format transmits an 8-bit luminance value for every pixel and a pair of chrominance values for every two pixels.

The camera converts the raw pixel data from the sensor to YUV 4:2:2. Since YUV 4:2:2 averages to 2 bytes per pixel, the YUV 4:2:2 pixel format requires two times the bandwidth of the 8-bit raw format, thus reducing the maximum possible frame rate.

GigEVision drivers see this pixel format as `YUV422_8`.



The *Device Driver for The Imaging Source GigE Cameras* offers this pixel format as the YUY2 video format.

5.1.1.5 YUV 4:1:1

This format transmits an 8-bit luminance value for every pixel and a pair of chrominance values for every four pixels.

The two YUV 4:1:1 pixel formats only differ in their byte order.

The camera converts the raw pixel data from the sensor to YUV 4:2:2. Since YUV 4:2:2 averages to 1.5 bytes per pixel, the YUV 4:2:2 pixel format requires two 50% more bandwidth than the 8-bit raw format, thus reducing the maximum possible frame rate.

GigEVision drivers see this pixel format as YCbCr411_8 and YCbCr411_8_CbYYCrYY.

The *Device Driver for The Imaging Source GigE Cameras* offers this pixel format as the Y411 video format.

5.1.1.6 RGB24

The camera converts the raw pixel data from the sensor to RGB24. Since RGB24 uses 3 bytes to store 1 pixel, the RGB24 pixel format requires three times the bandwidth of the 8-bit raw format, thus reducing the maximum possible frame rate.

GigEVision drivers enumerate this pixel format as BGR8.

The *Device Driver for The Imaging Source GigE Cameras* enumerates this pixel format as the RGB24 video format.

5.1.1.7 8-Bit Monochrome

The camera generates the pixel data by debayering the raw pixel data and transmitting only the luminance information.

GigEVision drivers enumerate this pixel format as Mono8.

5.1.2 Resolution

The DFM 47GR0521-ML allows the user to specify which rectangular region of the image sensor to read out during camera operation. The size of this rectangle determines the number of pixels that have to be transferred for each frame and has a significant influence on the required network bandwidth.

Lowering the resolution also often allows the image sensor to operate at a higher frame rate. Changes in the vertical resolution have more effect on the maximum frame rate than changes in the horizontal direction.

The way the resolution is controlled varies greatly between the driver technology used to access the camera:

- When using *GigE Vision*, the resolution is controlled through the GenICam features Width and Height.



- When using *IC Imaging Control*, the resolution is part of the video format, a parameter that combines pixel format, resolution and readout mode. For more information, refer to the *IC Imaging Control* documentation sections on `VideoFormat` and `VideoFormatDesc`.

Parameter	Horizontal Resolution
Minimum	256
Maximum	2592
GigEVision: GenICam	Width

Parameter	Vertical Resolution
Minimum	256
Maximum	1944
GigEVision: GenICam	Height

5.1.3 Readout Modes

The DFM 47GR0521-ML camera offers different sensor readout modes.

By default, the camera outputs all pixels of the image sensor.

In *skipping* modes, the image sensor regularly skips a number of rows and/or columns during readout. The resulting output image is smaller but contains the same field of view than the image produced by default readout mode.

In *binning* modes, a number of neighboring pixels is merged into one output pixel during readout. The nature of this merge operation is sensor-specific, most sensors either add the pixel values or average them.

Generally, binning modes provide better image quality than skipping modes. However, skipping modes usually provide a higher maximum frame rate.

The way the readout modes are controlled depends greatly upon which driver technology is used to access the camera:

- When using GigE Vision, the readout mode is controlled through the *GenICam* features `DecimationHorizontal`, `DecimationVertical`, `BinningHorizontal` and `BinningVertical`.
- When using *IC Imaging Control*, the readout mode is part of the video format - a parameter that which combines pixel format, resolution and readout mode. For more information, refer to the *IC Imaging Control* documentation sections on `VideoFormat` and `VideoFormatDesc`.

The following readout modes are supported:

- Default
- Binning 2X



- Binning 4X

5.1.4 Frame Rate

The frame rate is specified in frames per second and determines the camera's operating speed.

The way the frame rate is controlled depends greatly upon which driver technology is used to access the camera:

- When using *GigEVision*, the frame rate is controlled through the *GenICam* feature `AcquisitionFrameRate`.
- When using IC Imaging Control, the frame rate is selected from a list of available frame rates through APIs such as `Grabber::setFPS` or `ICImagingControl.DeviceFrameRate`.

The range of available frame rates depends upon other camera settings such as well, pixel format, resolution and readout modes.

Parameter	Frame Rate
Minimum	Depending on Pixel Format, Resolution, and Readout Mode
Maximum	Depending on Pixel Format, Resolution, and Readout Mode
GigEVision: GenICam	<code>AcquisitionFrameRate</code>

The following tables show the maximum frame rate for some combinations of pixel format and resolution.

8-Bit Bayer Raw

Width	Height	Maximum Frame Rate
2592	1944	22
1920	1080	54
640	480	234

12-Bit Packed Bayer Raw

Width	Height	Maximum Frame Rate
2592	1944	15
1920	1080	36
640	480	234

16-Bit Bayer Raw



Width	Height	Maximum Frame Rate
2592	1944	11
1920	1080	27
640	480	184

YUV 4:2:2

Width	Height	Maximum Frame Rate
2592	1944	11
1920	1080	27
640	480	184

YUV 4:1:1 (a)

Width	Height	Maximum Frame Rate
2592	1944	15
1920	1080	36
640	480	234

YUV 4:1:1 (b)

Width	Height	Maximum Frame Rate
2592	1944	15
1920	1080	36
640	480	234

RGB24

Width	Height	Maximum Frame Rate
2592	1944	7
1920	1080	18
640	480	123

8-Bit Monochrome



Width	Height	Maximum Frame Rate
2592	1944	22
1920	1080	54
640	480	234

5.1.5 Partial Scan Offset

If the selected resolution is smaller than the sensor size, the part of the sensor that is actually read out can be specified by the *Partial Scan Offset X* and *Partial Scan Offset Y* parameters. By default, the camera automatically positions the offsets so that the center of the sensor is used.

Parameter	Partial Scan Offset X
Minimum	0
Maximum	2336
GigEVision: GenICam	OffsetX
VCD Property	VCDID_PartialScanOffset \VCDElement_PartialScanOffsetX

Parameter	Partial Scan Offset Y
Minimum	0
Maximum	1688
GigEVision: GenICam	OffsetY
VCD Property	VCDID_PartialScanOffset \VCDElement_PartialScanOffsetY

If *Partial Scan Offset X* or *Partial Scan Offset Y* is configured to a value that would be invalid with the current setting of [Resolution](#) setting, the camera uses the maximum possible value.

Parameter	Partial Scan Auto Center
On	Automatically configure Partial Scan Offset X/Y so that the center area of the sensor is read out
True	
Off	Control Partial Scan Offset X/Y manually
False	
GigEVision: GenICam	OffsetAutoCenter
VCD Property	VCDID_PartialScanOffset \VCDElement_PartialScanAutoCenter



5.1.6 Image Flipping

The DFM 47GR0521-ML camera allows flipping of the image data horizontally, vertically, or both. The *Flip Horizontal* and *Flip Vertical* parameters can be used to control this sensor feature.

Parameter	Flip Horizontal
True	Image data is flipped horizontally
False	Image data is not flipped horizontally
GigEVision: GenICam	ReverseX
VCD Property	VCDID_FlipHorizontal\VCDElement_Value

Parameter	Flip Vertical
True	Image data is flipped vertically
False	Image data is not flipped vertically
GigEVision: GenICam	ReverseY
VCD Property	VCDID_FlipVertical\VCDElement_Value

5.2 Image Sensor Control

5.2.1 Exposure Time

The *Exposure Time* parameter defines the time the camera opens its (electronic) shutter when it is taking an image.

Parameter	Exposure Time
Minimum	100 μ s
Maximum	30 s
Default	auto
GigEVision: GenICam	ExposureTime
VCD Property	VCDID_Exposure\VCDElement_Value

5.2.2 Gain

The *Gain* parameter defines the amplification that is applied to the image at sensor level.



Parameter	Gain
Minimum	0 dB
Maximum	11,81 dB
Default	auto
GigE Vision: GenICam	Gain
VCD Property	VCDID_Gain\VCDElement_Value

5.2.3 Black Level

The *Black Level* parameter defines the lowest possible intensity value of the image sensor.

Parameter	Black Level
Minimum	0
Maximum	4095
Default	0
GigE Vision: GenICam	BlackLevel
VCD Property	VCDID_Brightness\VCDElement_Value

5.3 Automatic Exposure and Gain Control

The DFM 47GR0521-ML camera can automatically control gain and exposure time. These automatic functions are enabled by default.

In order to optimize image parameters, a region of interest can be specified for automatic functions. Specifying a region of interest enables fine-grained control over the image area for which the image parameters are optimized. A selection of pre-defined area presets is available, but the user can also specify the coordinates of a custom rectangle.

In certain situations, it is desirable to limit the range of the auto-controlled parameters. For example, one might want to avoid high gain settings in order to keep noise levels low. Other applications require limiting the maximum exposure time so that movements do not get blurred. Therefore, the ranges of the gain and exposure parameter can be limited.

If both auto exposure and auto gain are active, the camera tries to lower the gain value in order to reduce noise and improve the image quality.



5.3.1 Auto Exposure

Parameter	Auto Exposure
Continuous	Enable Auto Exposure
True	
Off	Disable Auto Exposure
False	
GigEVision: GenICam	ExposureAuto
VCD Property	VCDID_Exposure\VCDElement_Auto

5.3.2 Auto Gain

Parameter	Auto Gain
Continuous	Enable Auto Gain
True	
Off	Disable Auto Gain
False	
GigEVision: GenICam	GainAuto
VCD Property	VCDID_Gain\VCDElement_Auto

5.3.3 Auto Reference Value

The *Auto Reference Value* parameter specifies the target brightness for both auto exposure and auto gain.

Parameter	Auto Reference Value
Minimum	0
Maximum	255
Default	64
GigEVision: GenICam	ExposureAutoReference
VCD Property	VCDID_Exposure\VCDElement_AutoReference

5.3.4 Highlight Reduction

Enabling *Highlight Reduction* lets the auto exposure and auto gain functions reduce overexposed areas in the output image. This feature is particularly useful when using 10/12/16-bit output images and a tone mapping algorithm in post-processing when using higher bit depths as the dark areas still contain a lot of useful information.



Parameter	Highlight Reduction
True	Try to reduce overexposed areas
False	Ignore overexposed areas and focus on matching the image brightness to the selected Auto Reference Value .
GigEVision: GenICam	ExposureAutoHighlightReduction
VCD Property	VCDID_HighlightReduction\VCDElement_Value

5.3.5 Auto Exposure Limits

The *Auto Exposure Lower Limit* parameter determines the minimum possible value that can be set by the auto exposure algorithm.

Parameter	Auto Exposure Lower Limit
Minimum	100 μ s
Maximum	30 s
GigEVision: GenICam	ExposureAutoLowerLimit

The *Auto Exposure Upper Limit* parameter determines the maximum possible value that can be set by the auto exposure algorithm.

Parameter	Auto Exposure Upper Limit
Minimum	100 μ s
Maximum	30 s
GigEVision: GenICam	ExposureAutoUpperLimit
VCD Property	VCDID_Exposure\VCDElement_AutoMaxValue

If the *Auto Exposure Upper Limit Auto* parameter is enabled, the value of *Auto Exposure Upper Limit* is automatically kept at the maximum possible value for the current frame rate.

Parameter	Auto Exposure Upper Limit Auto
On	Select <i>Auto Exposure Upper Limit</i> automatically
Off	Let the user control <i>Auto Exposure Upper Limit</i>
GigEVision: GenICam	ExposureAutoUpperLimitAuto
VCD Property	VCDID_Exposure\VCDElement_AutoMaxValueAuto



5.3.6 Auto Gain Limits

The *Auto Gain Lower Limit* parameter determines the minimum possible value that can be set by the auto gain algorithm.

Parameter	Auto Gain Lower Limit
Minimum	0 dB
Maximum	11,81 dB
GigE Vision: GenICam	GainAutoLowerLimit

The *Auto Gain Upper Limit* parameter determines the maximum possible value that can be set by the auto gain algorithm.

Parameter	Auto Gain Upper Limit
Minimum	0 dB
Maximum	11,81 dB
GigE Vision: GenICam	GainAutoUpperLimit

5.4 Trigger

The trigger mode can be used to take images at very specific points in time which are specified by an electrical signal connected to the TRIGGER_IN pin of the I/O connector of the camera.

5.4.1 Trigger Mode

The *Trigger Mode* parameter enables the trigger mode.

Parameter	Trigger Mode
On	Enable Trigger Mode
True	
Off	Disable Trigger Mode
False	
GigE Vision: GenICam	TriggerMode
VCD Property	VCDID_Trigger\VCDElement_Value

5.4.2 Trigger Polarity

The *Trigger Polarity* parameter controls whether a trigger event is accepted on the rising or falling edge of the signal connected to the TRIGGER_IN line.



Parameter	Trigger Polarity
RisingEdge	Accept rising edge as trigger signal
True	
FallingEdge	Accept falling edge as trigger signal
False	
GigEVision: GenICam	TriggerActivation
VCD Property	VCDID_Trigger\VCDElement_Polarity

5.4.3 Software Trigger

The *Software Trigger* function can be used to simulate a trigger pulse, in turn causing one image to be exposed and delivered to the host computer.

Parameter	Software Trigger
Execute	Simulate one trigger pulse
GigEVision: GenICam	TriggerSoftware
VCD Property	VCDID_Trigger\VCDElement_SoftwareTrigger

5.4.4 Trigger Burst Count

The *Trigger Burst Count* parameter allows the camera to be configured to take more than one image per trigger pulse. By default, this parameter is set to 1 so that exactly one image is acquired. The images are taken as rapidly as possible given current settings (i.e. as limited by the current exposure time and frame rate settings).

Parameter	Trigger Burst Count
Minimum	1
Maximum	1000
Default	1
GigEVision: GenICam	AcquisitionBurstFrameCount
VCD Property	VCDID_Trigger\VCDElement_TriggerBurstCount

5.4.5 Trigger Source

The *Trigger Source* parameter allows the camera to be configured to only accept trigger signals from a specified source, e.g. only software trigger.



Parameter	Trigger Source
Any	Allow trigger signals from any source
Line1	Allow only hardware trigger
Software	Allow only software trigger
GigEVision: GenICam	TriggerSource

5.4.6 Trigger Overlap

The *Trigger Overlap* feature gives information on when a new trigger pulse is accepted in the trigger -> exposure -> readout sequence.

Parameter	Trigger Overlap
Off	The next trigger pulse is only accepted once the previous frame has been read out from the sensor
Readout	The next trigger pulse is accepted during readout as long as the remaining readout time is shorter than the exposure time
GigEVision: GenICam	TriggerOverlap
VCD Property	VCDID_Trigger\VCDElement_TriggerOverlap

5.5 Trigger Timing Parameters

The 47G series camera series offers several options for dealing with bad trigger signals. By using the *Debounce Time*, *Denoise Time* and *Mask Time* parameters, the camera can be configured to ignore pulses on its TRIGGER_IN line under certain conditions.

Useful values for these parameters are application-specific. They depend on the expected trigger frequency, the exposure time and assumptions about the input signal quality.

The default values for all these parameters is 0 μ s, assuming perfect signal quality.

5.5.1 Trigger Delay

The *Trigger Delay* parameter specifies a time for which the camera waits between receiving a trigger signal and starting the exposure of an image. Simulated trigger pulses generated through the *Software Trigger* function are not delayed by this parameter.



Parameter	Trigger Delay
Minimum	0 s
Maximum	1 s
Default	0 s
GigEVision: GenICam	TriggerDelay
VCD Property	VCDID_Trigger\VCDElement_TriggerDelay

5.5.2 Trigger Debounce Time

The *Trigger Debounce Time* parameter specifies the time for which the trigger input has to be low in order for the next trigger signal to be accepted.

Parameter	Trigger Debounce Time
Minimum	0 s
Maximum	1 s
Default	0 s
GigEVision: GenICam	TriggerDebouncer
VCD Property	VCDID_Trigger\VCDElement_TriggerDebouncer

5.5.3 Trigger Mask Time

The *Trigger Mask Time* parameter specifies the time for which trigger pulses are ignored after accepting a trigger signal.

Parameter	Trigger Mask Time
Minimum	0 s
Maximum	1 s
Default	0 s
GigEVision: GenICam	TriggerMask
VCD Property	VCDID_Trigger\VCDElement_TriggerMask

5.5.4 Trigger Noise Suppression Time

The *Trigger Noise Suppression Time* parameter specifies the time for which trigger input has to be active in order to be accepted as a trigger signal.



Parameter	Trigger Noise Suppression Time
Minimum	0 s
Maximum	1 s
Default	0 s
GigEVision: GenICam	TriggerDenoise
VCD Property	VCDID_Trigger\VCDElement_TriggerDenoise

5.6 Digital I/O

47G series cameras have one digital input and two digital outputs. The digital input can be used as a [Trigger](#) input, and the current status can also be examined directly.

The digital outputs can be configured as a [Strobe](#) output to signal the exact moment when the image sensor is sensitive to light so that external light sources can be synchronized to its operation cycle.

5.6.1 Line Selector

The *Line Selector* feature selects the physical line (or pin) of the external device connector to configure.

Parameter	Line Selector
Line0	Select Line 0
Line1	Select Line 1
Line2	Select Line 2
GigEVision: GenICam	LineSelector

If a line is selected, all other Line* features will be applied to its associated device pin:

- [Line Name](#)
- [Line Mode](#)
- [Line Inverter](#)
- [Line Status](#)
- [Line Status Invalidate](#)
- [Line Source](#)
- [Line Format](#)

5.6.2 Line Name

Line Name returns the name of the line selected by [Line Selector](#).

Parameter	Line Name
GigEVision: GenICam	LineName



5.6.3 Line Mode

Line Mode is a read-only feature indicating the direction of the line selected by [Line Selector](#).

Parameter	Line Mode
Input	The selected line is an input.
Output	The selected line is an output.
GigEVision: GenICam	LineMode

5.6.4 Line Inverter

The *Line Inverter* feature can be used to invert the output signal of the line selected by [Line Selector](#).

Line Inverter is only available if the [Line Mode](#) of the selected line is set to *Output*.

Parameter	Line Inverter
False	The line signal is not inverted.
True	The line signal is inverted.
GigEVision: GenICam	LineInverter

5.6.5 Line Status

The *Line Status* feature returns the current status of the line selected by [Line Selector](#).

The status of the signal is taken after the signal was possible inverted by [Line Inverter](#).

Line Status is only available if the [Line Mode](#) of the selected line is set to *Input*.

Parameter	Line Status
True	The level of the line signal is High.
False	The level of the line signal is Low.
GigEVision: GenICam	LineStatus

5.6.6 Line Status Invalidate

Line Status Invalidate invalidates the value of [Line Status](#), causing it to be re-read from the device.

Parameter	Line Status Invalidate
Execute	Invalidates the value of <i>LineStatus</i> .
GigEVision: GenICam	LineStatusInvalidate



5.6.7 Line Source

Line Source selects which internal I/O source signal is output on the line selected by [Line Selector](#).

The *Line Source* feature is only available if the [Line Mode](#) of the selected line is set to *Output*.

Parameter	Line Source
UserOutput0	The line outputs the User Output Bit 0 state as defined by User Output Value .
UserOutput1	The line outputs the User Output Bit 1 state as defined by User Output Value .
UserOutput2	The line outputs the User Output Bit 2 state as defined by User Output Value .
ExposureActive	Device is doing exposure of a frame.
GigEVision: GenICam	LineSource

5.6.8 Line Format

Line Format indicates the electrical format of the selected line selected by [Line Selector](#).

Parameter	Line Format
TTL	The Line is currently accepting or sending TTL level signals.
OptoCoupled	The Line is opto-coupled.
OpenDrain	The Line is Open Drain.
GigEVision: GenICam	LineFormat

5.6.9 User Output Selector

User Output Selector selects which bit of the user output register will be set by [User Output Value](#).

The bits in the user output register can be selected as source signal in [Line Source](#).

Parameter	User Output Selector
UserOutput0	Selects bit 0 of the user output register.
UserOutput1	Selects bit 1 of the user output register.
UserOutput2	Selects bit 2 of the user output register.
GigEVision: GenICam	UserOutputSelector



5.6.10 User Output Value

The *User Output Value* feature sets the value of the bit selected by [User Output Selector](#).

The bits in the user output register can be selected as source signal in [Line Source](#).

Parameter	User Output Value
False	Set the bit to 0.
True	Set the bit to 1.
GigEVision: GenICam	UserOutputValue

5.7 Strobe

The strobe function controls the automatic generation of output pulses on the STROBE_OUT pin which is synchronized to the image sensor's exposure time.

5.7.1 Strobe Enable

The *Strobe Enable* parameter enables the automatic generation of strobe pulses.

Parameter	Strobe Enable
On	Strobe enabled
True	
Off	Strobe disabled
False	
GigEVision: GenICam	StrobeEnable
VCD Property	VCDID_Strobe\VCDElement_Value

5.7.2 Strobe Polarity

The *Strobe Polarity* parameter can be used to invert the strobe pulse output.

Parameter	Strobe Polarity
ActiveHigh	The STROBE_OUT pin is logically high during the exposure time
True	
ActiveLow	The STROBE_OUT pin is logically low during the exposure time
False	
GigEVision: GenICam	StrobePolarity
VCD Property	VCDID_Strobe\VCDElement_StrobePolarity



5.7.3 Strobe Operation

The *Strobe Operation* parameter specifies how the length of the strobe pulses are controlled.

Parameter	Strobe Operation
Exposure	Output pulse duration is equal to the current exposure time
True	
GigEVision: GenICam	StrobeOperation
VCD Property	VCDID_Strobe\VCDElement_StrobeMode

5.8 White Balance

The DFM 47GR0521-ML color camera can perform white balance by digital multiplication of the appropriate raw pixel values.

5.8.1 Auto White Balance

DFM 47GR0521-ML can perform *Auto White Balance*. It can be enabled continuously when changes in lighting conditions are expected. Under controlled lighting conditions, however, one-time white balance calibration is the recommended approach.

To perform one-time white balance calibration, place a reference white sheet in front of the camera and set `BalanceWhiteAuto` to *Once*. The camera will then find the correct white balance settings for the current light conditions and keep them active until instructed otherwise.

Parameter	Auto White Balance
Continuous	Enable automatic white balance
True	
Once	Enable automatic white balance until the color channels have been balanced once
One Push	
Off	Disable automatic white balance
False	
GigEVision: GenICam	BalanceWhiteAuto
VCD Property	VCDID_WhiteBalance\VCDElement_Auto VCDID_WhiteBalance\VCDElement_OnePush

5.8.2 White Balance Mode

The default auto white balance algorithm is *Gray World*. It is selected by setting the *White Balance Mode* accordingly. The *Gray World* algorithm operates under the assumption that the average color of a scene is near gray and adjusts the white balance coefficients so the



average color of the resulting image is gray as well. In the case where this assumption is wrong (e.g. the camera is pointing at a blue carpet), the auto white balance algorithm will select coefficients that do not result in a visually accurate image.

To avoid the problems posed by the *Gray World* algorithm, the *Temperature* mode can be used. This mode operates by trying to determine the color temperature of the light source.

Parameter	White Balance Mode
Gray World	Use the <i>Gray World</i> model
Temperature	Use the <i>Temperature</i> model
GigEVision: GenICam	BalanceWhiteMode
VCD Property	VCDID_WhiteBalance \VCDElement_WhiteBalanceMode

To assist the automatic white balance temperature detection, *White Balance Auto Preset* can be used to limit the range of valid color temperatures.

Parameter	White Balance Auto Preset
Any	Allow any color temperature
Auto Warm White	Limit color temperature to approximately 2500-4000 K
Auto Cool White	Limit color temperature to approximately 4000-5800 K
Auto Daylight	Limit color temperature to approximately 5700-7500 K
Auto Deep Shade	Limit color temperature to approximately 7500-10000 K
GigEVision: GenICam	BalanceWhiteAutoPreset
VCD Property	VCDID_WhiteBalance \VCDElement_WhiteBalanceAutoPreset

5.8.3 Manual White Balance

If *Auto White Balance* is not enabled, the amplifiers for the red, green and blue channels can be controlled manually.

Parameter	White Balance Red
Minimum	0
Maximum	3.984375
Default	auto
GigEVision: GenICam	BalanceRatio[BalanceRatioSelector=Red]
VCD Property	VCDID_WhiteBalance \VCDElement_WhiteBalanceRed



Parameter	White Balance Green
Minimum	0
Maximum	3.984375
Default	auto
GigEVision: GenICam	BalanceRatio[BalanceRatioSelector=Green]
VCD Property	VCDID_WhiteBalance \VCDElement_WhiteBalanceGreen

Parameter	White Balance Blue
Minimum	0
Maximum	3.984375
Default	auto
GigEVision: GenICam	BalanceRatio[BalanceRatioSelector=Blue]
VCD Property	VCDID_WhiteBalance \VCDElement_WhiteBalanceBlue

If *White Balance Mode* is set to *Temperature*, the color temperature can be set directly. Additionally, a light source can be selected from a list of presets.

Parameter	White Balance Temperature
Minimum	2500 K
Maximum	10000 K
Default	auto
GigEVision: GenICam	BalanceWhiteTemperature
VCD Property	VCDID_WhiteBalance \VCDElement_WhiteBalanceTemperature



Parameter	White Balance Temperature Preset
Sodium-Vapor Lamp	2500 K
Warm Light	2700 K
Halogen Light	3000 K
Neutral White	3500 K
Cool White Fluorescent Light	4000 K
Cool White/Daylight (CFL)	5000 K
Daylight	6000 K
Cool White LED	7500 K
Blue Sky	10000 K
GigEVision: GenICam	BalanceWhiteTemperaturePreset
VCD Property	VCDID_WhiteBalance \VCDElement_TemperaturePreset

5.9 Image Processing

5.9.1 Gamma

The 47G series cameras can perform gamma correction on the image data. If the pixel format of a color camera is set a YUV mode, gamma correction is applied to the Y channel. In bayer raw and RGB24 modes, all color channels are subject to the same gamma correction.

Parameter	Gamma
Minimum	0.3
Maximum	1.2
Default	0.55
GigEVision: GenICam	Gamma
VCD Property	VCDID_Gamma\VCDElement_Value

5.9.2 Lookup Table

The 47G series allows the user to specify a lookup table (LUT) that can transform pixel values. This lookup table can be used to perform tasks like histogram equalization inside the camera.



If the pixel format of a color camera is set to one of the YUV modes, the lookup table is applied only to the Y channel. In bayer raw and RGB24 modes, all color channels are subject to the same lookup operation.

The lookup table has 257 16-bit entries. The upper 8 bits of the image data are used to select the appropriate entry in the lookup table, while the remaining bits are used to interpolate between the selected entry and one of its neighbors.

The *LUT Enable* feature enables the lookup table.

Parameter	LUT Enable
True	Enable lookup table operation
False	Disable lookup table operation
GigEVision: GenICam	LUTEnable

The lookup table values can be programmed using the *LUT Index* and *LUT Value* features.

Parameter	LUT Index
Minimum	0
Maximum	256
GigEVision: GenICam	LUTIndex

Parameter	LUT Value
Minimum	0
Maximum	65535
GigEVision: GenICam	LUTValue

The whole lookup table can be quickly reprogrammed through the *LUT Value All* feature.

Parameter	LUT Value All
Value	1028 bytes of memory containing 257 LUT entries. Each 16-bit LUT entry is aligned on a 32-bit boundary
GigEVision: GenICam	LUTValueAll

Important: Since gamma correction is implemented using the same hardware as the lookup table, gamma correction is disabled when the lookup table is enabled.



5.10 Color Processing

The DFM 47GR0521-ML color camera allows color adjustments with the *Hue* and *Saturation* parameters. These adjustments work with all output pixel formats.

Important: When a bayer raw pixel format is selected, *Hue* and *Saturation* still work. However, when at least one of them is enabled (set to non-default value), the resulting image is slightly blurred because of the way these parameters are implemented internally.

5.10.1 Hue

The *Hue* parameter controls the color angle of the output image.

Parameter	Hue
Minimum	-180
Maximum	180
Default	0
GigEVision: GenICam	Hue
VCD Property	VCDID_Hue\VCDElement_Value

5.10.2 Saturation

The *Saturation* parameter controls the color saturation of the output image.

Parameter	Saturation
Minimum	0
Maximum	255
Default	64
GigEVision: GenICam	Saturation
VCD Property	VCDID_Saturation\VCDElement_Value

5.10.3 Color Correction Matrix

As seen in the [Spectral Characteristics](#) diagram, the frequencies at which the red, green and blue pixels respond to incoming light overlap. This causes the colors of objects in captured images to differ from the colors of the same objects seen in reality.

A RGB to RGB color correction matrix can be used to change the pixel data output of the camera so that the colors in captured image are a closer match to what is expected by human observers.



Parameter	Enable Color Correction Matrix
True	Enable Color Correction Matrix
False	Disable Color Correction Matrix
GigEVision: GenICam	ColorTransformationEnable
VCD Property	VCDID_ColorMatrix\VCDElement_Value

By default, the values of the color matrix coefficients are initialized with values optimized for skin tones and other everyday objects.

If necessary, the matrix coefficients can be controlled manually.

When using *GenICam*, select a coefficient using `ColorTransformationValueSelector` and then change it via the `ColorTransformationValue`.

When using *IC Imaging Control*, the matrix coefficients are controlled via the `VCDElement_ColorMatrix[RGB][RGB]` elements of `VCDID_ColorMatrix`.

Parameter	Red contribution to the red pixel
Minimum	-1.0
Maximum	3.0
GigEVision: GenICam	ColorTransformationValue [ColorTransformationValueSelector=Gain00]
VCD Property	VCDID_ColorMatrix \VCDElement_ColorMatrixRR

Parameter	Green contribution to the red pixel
Minimum	-1.0
Maximum	3.0
GigEVision: GenICam	ColorTransformationValue [ColorTransformationValueSelector=Gain01]
VCD Property	VCDID_ColorMatrix \VCDElement_ColorMatrixRG

Parameter	Blue contribution to the red pixel
Minimum	-1.0
Maximum	3.0
GigEVision: GenICam	ColorTransformationValue [ColorTransformationValueSelector=Gain02]
VCD Property	VCDID_ColorMatrix \VCDElement_ColorMatrixRB



Parameter	Red contribution to the green pixel
Minimum	-1.0
Maximum	3.0
GigEVision: GenICam	ColorTransformationValue [ColorTransformationValueSelector=Gain10]
VCD Property	VCDID_ColorMatrix \VCDElement_ColorMatrixGR

Parameter	Green contribution to the green pixel
Minimum	-1.0
Maximum	3.0
GigEVision: GenICam	ColorTransformationValue [ColorTransformationValueSelector=Gain11]
VCD Property	VCDID_ColorMatrix \VCDElement_ColorMatrixGG

Parameter	Blue contribution to the green pixel
Minimum	-1.0
Maximum	3.0
GigEVision: GenICam	ColorTransformationValue [ColorTransformationValueSelector=Gain12]
VCD Property	VCDID_ColorMatrix \VCDElement_ColorMatrixGB

Parameter	Red contribution to the blue pixel
Minimum	-1.0
Maximum	3.0
GigEVision: GenICam	ColorTransformationValue [ColorTransformationValueSelector=Gain20]
VCD Property	VCDID_ColorMatrix \VCDElement_ColorMatrixBR

Parameter	Green contribution to the blue pixel
Minimum	-1.0
Maximum	3.0
GigEVision: GenICam	ColorTransformationValue [ColorTransformationValueSelector=Gain21]
VCD Property	VCDID_ColorMatrix \VCDElement_ColorMatrixBG



Parameter	Blue contribution to the blue pixel
Minimum	-1.0
Maximum	3.0
GigE Vision: GenICam	ColorTransformationValue [ColorTransformationValueSelector=Gain22]
VCD Property	VCDID_ColorMatrix \VCDElement_ColorMatrixBB

5.11 Region of Interest for Auto Functions

The 47G series cameras allow for the setting of a region of interest that is used while controlling the [Auto Exposure](#), [Auto Gain](#) and [Auto White Balance](#) functions.

5.11.1 Auto Functions ROI Enable

The *Auto Functions ROI Enable* parameter allows for the use of a region of interest for auto functions.

Parameter	Auto Functions ROI Enable
True	Auto functions only take a specified part of the image into account
False	Auto functions look at the whole image
GigE Vision: GenICam	AutoFunctionsROIEnable
VCD Property	VCDID_AutoRoi\VCDElement_Value

5.11.2 Auto Functions ROI Preset

The *Auto Functions ROI Preset* parameter lets the user select from a list of ROI presets.

Parameter	Auto Functions ROI Preset
Full Sensor	Select the full output image
Center 50%	Select a rectangular area in the center of the output image
Center 25%	Select a small rectangular area in the center of the output image
Bottom Half	Select the bottom half of the output image
Top Half	Select the top half of the output image
Custom Rectangle	Select a custom rectangle for fine-grained control
GigE Vision: GenICam	AutoFunctionsROI_Preset
VCD Property	VCDID_AutoRoi\VCDElement_AutoRoiPreset



5.11.3 Auto Functions ROI Custom Rectangle

When *Auto Functions ROI Preset* is set to *Custom Rectangle*, the user can manually set the position and size of the region of interest. The coordinates are relative to the origin of the current video format as specified by [Partial Scan Offset](#).

Parameter	Auto Functions ROI Left
Minimum	0
Maximum	2576
GigE Vision: GenICam	AutoFunctionsROILeft
VCD Property	VCDID_AutoRoi \VCDElement_AutoRoiLeftRelative

Parameter	Auto Functions ROI Top
Minimum	0
Maximum	1928
GigE Vision: GenICam	AutoFunctionsROITop
VCD Property	VCDID_AutoRoi \VCDElement_AutoRoiTopRelative

Parameter	Auto Functions ROI Width
Minimum	16
Maximum	2592
GigE Vision: GenICam	AutoFunctionsROIWidth
VCD Property	VCDID_AutoRoi \VCDElement_AutoRoiWidthRelative

Parameter	Auto Functions ROI Height
Minimum	16
Maximum	1944
GigE Vision: GenICam	AutoFunctionsROIHeight
VCD Property	VCDID_AutoRoi \VCDElement_AutoRoiHeightRelative

5.12 User Sets

The 47G series cameras can store their complete configuration into built-in non-volatile memory. The camera configuration can be saved into and restored from one of two



available memory slots upon user's request. Additionally, the camera can be configured to load one of the user's camera configurations at startup.

5.12.1 User Set Selector

The *User Set Selector* parameter selects the memory slot on which consecutive load and save commands are executed.

Parameter	User Set Selector
UserSet1	First of the two memory slots for user configurations
UserSet2	Second of the two memory slots for user configurations
Default	A special memory slot that always contains the camera's factory default configuration. It cannot be overwritten
GigEVision: GenICam	UserSetSelector

5.12.2 Load User Set

By using the *Load User Set* command, the user can restore the camera configuration from the memory slot selected by *User Set Selector*.

Parameter	Load User Set
Execute	Restore the camera configuration from the memory slot specified by <i>User Set Selector</i>
GigEVision: GenICam	UserSetLoad

5.12.3 Save User Set

By using the *Save User Set* command, the user can save the camera configuration into the memory slot selected by *User Set Selector*.

Parameter	Save User Set
Execute	Save the current camera configuration into the memory slot specified by <i>User Set Selector</i>
GigEVision: GenICam	UserSetSave

5.12.4 Default User Set

The *Default User Set* parameter controls the camera's startup behavior. It selects which memory slot is used for device initialization when the camera is powered up.



Parameter	Default User Set
UserSet1	Load configuration from the first memory slot
UserSet2	Load configuration from the second memory slot
Default	Load factory default configuration
GigEVision: GenICam	UserSetDefault

5.13 Precision Time Protocol

The 47G series can synchronize its internal clock to other devices via *Precision Time Protocol* (PTP, IEEE 1588).

When multiple PTP devices are connected through the same network, they will synchronize their clocks. This allows the image timestamps to remain comparable between cameras.

A camera running with PTP enabled can also schedule actions to be executed at a specified time point in the future through *Scheduled Actions*.

PTP is enabled by default.

5.13.1 PTP Enable

The *PTP Enable* parameter enables or disables the camera's usage of the *Precision Time Protocol*.

Parameter	PTP Enable
True	Use Precision Time Protocol
False	PTP disabled
GigEVision: GenICam	PtpEnable

5.13.2 PTP Status

PTP Status is a read-only feature that reports the current status of the *Precision Time Protocol* algorithm.

Parameter	PTP Status
Master	The camera acts as PTP master clock.
Slave	The camera synchronizes its time stamp to a PTP master clock.
Uncalibrated	PTP was recently enabled, or a recent change in the network configuration initiated a resynchronization.
Disabled	PTP is disabled.
GigEVision: GenICam	PtpStatus



5.14 Action Scheduler

When *Precision Time Protocol* is enabled, the action scheduler can be used to plan and run actions at some point in the future.

The only action the camera can perform right now is triggering images.

Action triggers are only accepted when [Trigger Source](#) is set to `Action0` or `Any`.

5.14.1 Action Selector

The *Action Selector* feature selects the action that the [Action Scheduler Time](#), [Action Scheduler Interval](#), [Action Scheduler Commit](#) and [Action Scheduler Cancel](#) features act on.

Parameter	Action Selector
0	<code>Action0</code> , which is hard-wired to trigger images
GigEVision: GenICam	<code>ActionSelector</code>

5.14.2 Action Scheduler Time

The *Action Scheduler Time* is the time for when an action is scheduled, specified as a PTP timestamp in nanosecond units.

Scheduling the action to a time in the past will cause the action to be performed immediately.

Scheduling a repeated action to start in the past will ignore missed actions and continue as if it had been scheduled earlier.

Parameter	Action Scheduler Time
GigEVision: GenICam	<code>ActionSchedulerTime</code>

5.14.3 Action Scheduler Interval

The *Action Scheduler Interval* feature allows instructing the action scheduler to repeat the scheduled action in a fixed interval, indefinitely.

If the interval is set to 0, the action is performed once and not repeated.

The interval is specified in microseconds.

Parameter	Action Scheduler Interval
Minimum	0
Maximum	4294967295 us
GigEVision: GenICam	<code>ActionSchedulerInterval</code>



5.14.4 Action Scheduler Commit

Executing the *Action Scheduler Commit* command commits an action to the queue of scheduled actions.

The action is planned to be performed at the time specified by [Action Scheduler Time](#).

If [Action Scheduler Interval](#) has a value other than 0, the action will be repeated with the specified interval indefinitely, or until the [Action Scheduler Cancel](#) command is executed.

There is a finite number of queue slots available, trying to queue too many actions will fail. The maximum length of the queue is reported by the `ActionQueueSize` feature.

Parameter	Action Scheduler Commit
Execute	Schedule the action specified by Action Selector to be performed at a specified time in the future.
GigEVision: GenICam	<code>ActionSchedulerCommit</code>

5.14.5 Action Scheduler Cancel

Executing the *Action Scheduler Cancel* command cancels all scheduled actions of the action type selected by [Action Selector](#).

Parameter	Action Scheduler Cancel
Execute	Cancel all scheduled actions of the type specified by Action Selector.
GigEVision: GenICam	<code>ActionSchedulerCancel</code>

5.15 Events

47G series devices can send asynchronous event packets, notifying the application about certain events during device operation.

To enable a specific event, select the event to enable in [Event Selector](#) and then set [Event Notification](#) to *On*.

The way to receive the event notifications depends on the used camera SDK. In most cases, a notification handler has to be registered on the feature named after the event, e.g. *EventTest* or *EventExposureEnd*. Additional event data can often be queried via additional features with a derived name, e.g. *EventTestTimestamp* or *EventExposureEndFrameID*.

5.15.1 Event Selector

The *Event Selector* parameter selects an event to configure.



Parameter	Event Selector
FrameTriggerMissed	Selects the FrameTriggerMissed event
Line1FallingEdge	Selects the Line1FallingEdge event
Line1RisingEdge	Selects the Line1RisingEdge event
Test	Selects the Test event
GigEVision: GenICam	EventSelector

5.15.2 Event Notification

The *Event Notification* parameter enables or disables the event selected by [Event Selector](#).

Parameter	Event Notification
On	Enables notifications for the selected event
Off	Disables notifications for the selected event
GigEVision: GenICam	EventNotification

5.15.3 Event Frame Trigger Missed

The *Event Frame Trigger Missed* feature is notified when the camera receives a trigger pulse, but the sensor was not in a state where a new exposure could be started.

The value of this feature has no meaning and should not be read.

Parameter	Event Frame Trigger Missed
GigEVision: GenICam	EventFrameTriggerMissed

The *Event Frame Trigger Missed Timestamp* parameter identifies the point in time when the current frame trigger missed event occurred.

Please refer to the documentation of your camera SDK on how to safely read the timestamp associated with the current event when a notification is received.

Parameter	Event Frame Trigger Missed Timestamp
GigEVision: GenICam	EventFrameTriggerMissedTimestamp

5.15.4 Event Line1 Falling Edge

The *Event Line1 Falling Edge* feature is notified when the input on Line1 changes from high to low.

The value of this feature has no meaning and should not be read.



Parameter	Event Line1 Falling Edge
GigEVision: GenICam	EventLine1FallingEdge

The *Event Line1 Falling Edge Timestamp* parameter identifies the point in time when the current line1 falling edge event occurred.

Please refer to the documentation of your camera SDK on how to safely read the timestamp associated with the current event when a notification is received.

Parameter	Event Line1 Falling Edge Timestamp
GigEVision: GenICam	EventLine1FallingEdgeTimestamp

5.15.5 Event Line1 Rising Edge

The *Event Line1 Rising Edge* feature is notified when the input on Line1 changes from high to low.

The value of this feature has no meaning and should not be read.

Parameter	Event Line1 Rising Edge
GigEVision: GenICam	EventLine1RisingEdge

The *Event Line1 Rising Edge Timestamp* parameter identifies the point in time when the current line1 rising edge event occurred.

Please refer to the documentation of your camera SDK on how to safely read the timestamp associated with the current event when a notification is received.

Parameter	Event Line1 Rising Edge Timestamp
GigEVision: GenICam	EventLine1RisingEdgeTimestamp

5.15.6 Event Test

The *Event Test* feature is notified when a test event occurs.

To generate a test event, use the *Test Event Generate* command.

The value of this feature has no meaning and should not be read.

Parameter	Event Test
GigEVision: GenICam	EventTest

The *Event Test Timestamp* parameter identifies the point in time when the current test event occurred.



Please refer to the documentation of your camera SDK on how to safely read the timestamp associated with the current event when a notification is received.

Parameter	Event Test Timestamp
GigEVision: GenICam	EventTestTimestamp

The *Test Event Generate* command can be used to generate a test event.

Parameter	Test Event Generate
Execute	Generate one test event
GigEVision: GenICam	TestEventGenerate

5.16 Bandwidth Control

When using multiple 47G series devices connected to the same network adapter or host controller, the data rate has to be considered to allow consistent operation.

To limit the bandwidth of a camera, set [Device Link Throughput Limit Mode](#) to On, and set [Device Link Throughput Limit](#) to the desired maximum data rate.

5.16.1 Device Link Throughput Limit Mode

The *Device Link Throughput Limit Mode* parameter enables or disables the effect of [Device Link Throughput Limit](#).

If set, the camera's internal frame rate is automatically reduced to fit into the available bandwidth.

An inter-packet delay is added between streaming packets to ensure the network bandwidth does not exceed the limit.

Parameter	Device Link Throughput Limit Mode
Off	The bandwidth the device uses for streaming is unlimited.
On	The maximum bandwidth the device uses for streaming is defined by Device Link Throughput Limit .
GigEVision: GenICam	DeviceLinkThroughputLimitMode

5.16.2 Device Link Throughput Limit

The *Device Link Throughput Limit* parameter defines the maximum bandwidth used by the device to stream data.

[Device Link Throughput Limit Mode](#) must be set to On for *Device Link Throughput Limit* to have an effect.



Parameter	Device Link Throughput Limit
Minimum	1000000 Mbps
Maximum	125000000 Mbps
GigEVision: GenICam	DeviceLinkThroughputLimit



6 Temperature Measurement Point

Device temperature in operating state is measured on the back side of the circuit board of DFM 47GR0521-ML:

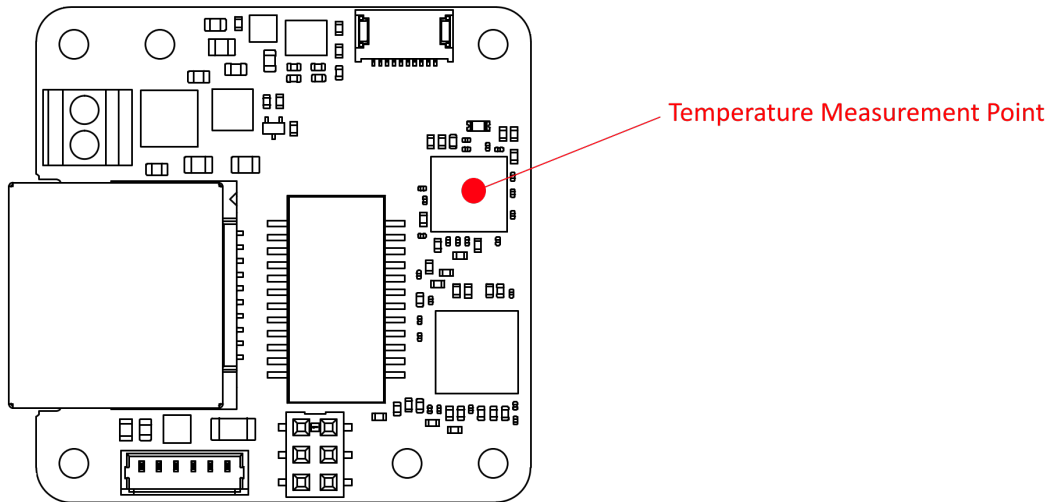



7 Revision History

Date	Version	Description
2024/9/20		Initial Release of this document



DFM 47GR0521-ML Technical Reference Manual

All product and company names in this document may be trademarks and tradenames of their respective owners and are hereby acknowledged.

The Imaging Source Europe GmbH cannot and does not take any responsibility or liability for any information contained in this document. The source code presented in this document is exclusively used for didactic purposes. The Imaging Source does not assume any kind of warranty expressed or implied, resulting from the use of the content of this document or the source code.

The Imaging Source Company reserves the right to make changes in specifications, function or design at any time and without prior notice.

Last update: November 2024

© 2024 The Imaging Source

All rights reserved. Reprint, also in parts, only allowed with permission of The Imaging Source Europe GmbH.

All weights and dimensions are approximate. Unless otherwise specified, the lenses shown in the context of cameras are not shipped with these cameras.

Headquarters:

*The Imaging Source Europe GmbH
Überseetor 18, D-28217 Bremen, Germany
Phone: +49 421 33591-0*

North & South America:

*The Imaging Source, LLC
4600 Park Road, Suite 470, Charlotte, NC 28209, United States
Phone: +1 877-462-4772*

Asia Pacific:

*The Imaging Source Asia Co., Ltd.
3F., No. 43-7/8, Zhongxing Road
Xizhi District, New Taipei City 221012, Taiwan
Phone: +886 2-2792-3153*

www.theimagingsource.com