

VC-101MX-M/C 9 H VC-151MX-M/C 6 H

Ultra High Resolution CMOS Digital Camera



CoaXPress®

The VC-101MX and VC-151MX, the latest models of the industrial proven VC series, are new 101 and 151 megapixel CoaXPress cameras and based on the latest CMOS image sensor technology (IMX461 and IMX411) from Sony Semiconductor Solutions Corporation. The VC-101MX-9 offers up to 8.7 frames per second at 11648×8742 resolution. For even higher resolution applications, the VC-151MX-6 offers up to 6.2 frames per second at 14192×10640 resolution. Equipped with the Vieworks' innovative technologies proved by world's top FPD manufacturers, the VC-101MX and VC-151MX cameras offer not only highly uniformed images but also high speed image processing capabilities. Featured with high quality image uniformity and high resolution, these cameras are ideal for demanding applications such as FPD, PCB and semiconductor inspections.

VIEWORKS

www.vieworks.com

VC-101MX-9 H / VC-151MX-6 H

Ultra High Resolution CMOS Digital Camera

Main Features

- 101 or 151 Megapixel Resolution
- CoaXPress Interface
- Electronic Rolling Shutter
- DSNU and PRNU Correction
- Flat Field Correction with Sequencer Control
- Hot Pixel Correction
- Dynamic Defective Pixel Correction

Applications

- Flat Panel Display Inspection
- Electronics Inspection
- Semiconductor Inspection
- Document / Film Scanning

Specifications

Model		VC-101MX-M/C 9 H	VC-151MX-M/C 6 H
Resolution (H × V)		11648 × 8742	14192 × 10640
Sensor		SONY IMX461	SONY IMX411
Sensor Size (Diagonal)		43.80 mm × 32.87 mm (55 mm)	53.36 mm × 40.01 mm (66.7 mm)
Pixel Size		3.76 μm × 3.76 μm	3.76 μm × 3.76 μm
Interface		CoaXPress	
Max. Frame Rate		8.7 fps (with Overlapped Acquisition)	6.2 fps (with Overlapped Acquisition)
Exposure Time (1 μs step)		1 μs – 60 s	
Pixel Data Format		8 / 10 / 12 bit	
Electronic Shutter		Rolling Shutter	
Trigger Synchronization	Overlapped Acquisition	Free-Run	
	Non-overlapped Acquisition	Hardware Trigger, Software Trigger or CXP	
Dynamic Range		78 dB	
Gain Control		1 × ~ 32 ×	
Black Level Control		0 ~ 255 LSB at 12 bit	
Dimension / Weight		90 mm × 90 mm × 92.5 mm, 800 g (with M-72 mount)	100 mm × 100 mm × 92.5 mm, 1070 g (with M-72 mount)
Temperature		Operating: 0°C ~ 40°C, Storage: -40°C ~ 70°C	
Software Trigger		Asynchronous, Programmable via Camera API	
Lens Mount		M72-mount, Custom mount available upon request	
Power	External	11 ~ 24 V DC	
	Dissipation	Typ. 15.5 W	
Compliance		CE, FCC, KC	
API SDK		Viewworks Imaging Solution 7.X	

VC-101MX-9 H / VC-151MX-6 H

Ultra High Resolution CMOS Digital Camera

Relative Sensitivity Curves

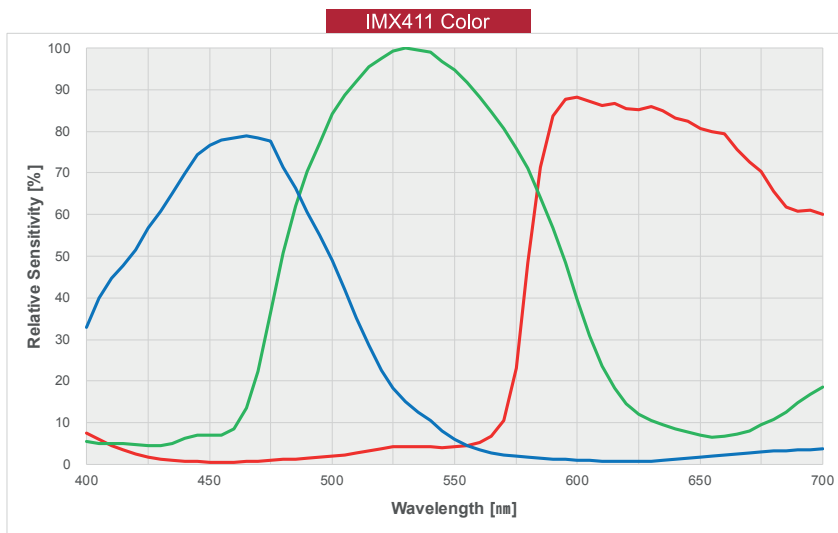
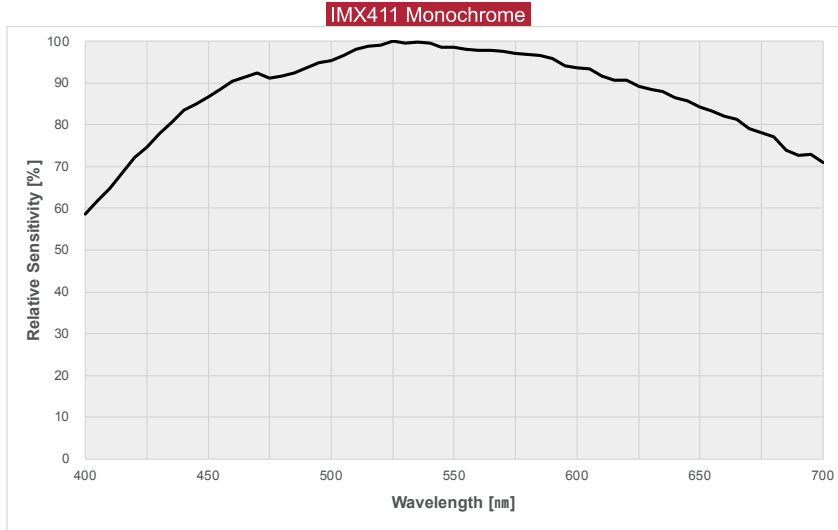

Ordering Scheme

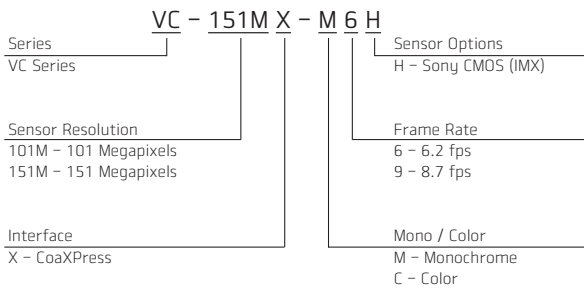

Connector Specification

Power



1, 2, 3: +12V DC 4, 5, 6: GND
(HR10A-7R-6PB)

Control

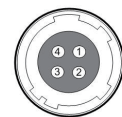

1: Trigger IN+ 2: Trigger IN-
3: Strobe Out-(GND) 4: Strobe OUT+
(HR10A-7R-4S)

Data Transfer / Communications

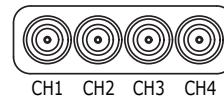

CH1: Master Connection
(75 Ω, DIN 1.0/2.3)

Connectors on camera body

VC-101MX-9 H / VC-151MX-6 H

Ultra High Resolution CMOS Digital Camera

Mechanical Dimensions

Unit: mm

VC-101MX-M/C 9 H

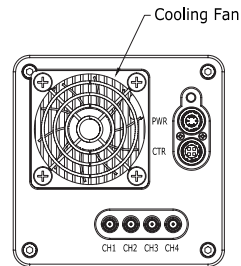
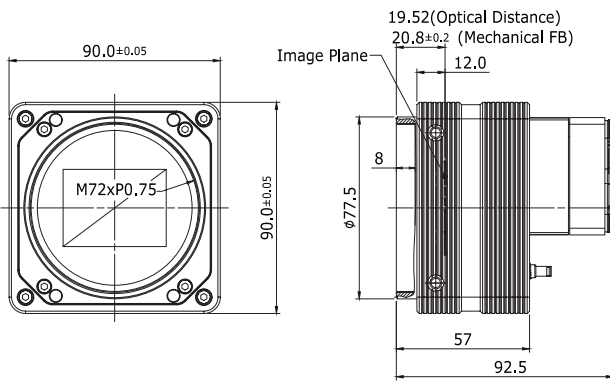
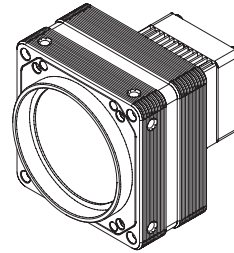
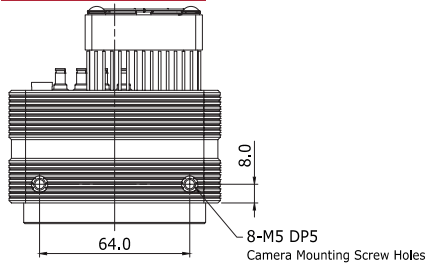

VC-151MX-M/C 6 H

